

LED

MUSIC LINE

**SISTEM  
MODERNE  
DEKORATIVNE  
LED RASVETE**

**ZA RASVETU STEPENIŠTA,  
NAMEŠTAJA, HODNIKA, KAFIĆA  
I KAO PANIK RASVETA**

**gals**

**NOVO !!! NOVO !!! NOVO !!! NOVO !!! NOVO !!! NOVO !!! NOVO !!!**

# MUSIC LINE

MUSIC LINE led rasvetna tela imaju široku primenu, npr.: **kod rasvete stepeništa, hodnika, zidova, vitrina i kuhinjskog namešaja**; mogu se koristiti i kao **panik rasveta**.

Ova tela mogu biti montirana direktno na zapaljivu površinu, u već pripremljene otvore od  $\varnothing 50$  - MINI ili  $\varnothing 60$  - STANDARD i DUO, kao i u standardne kutije za instalaciju. STICK rasvetna tela su prilagodjena za neposredno lepljenje na površinu uz pomoc lepka ili adhezivne trake.

MUSIC LINE proizvodi koriste moderan LED rasvetni sistem, koji karakteriše visok nivo osvetljenja i veoma mala potrošnja energije, što znaci da ova rasveta radi neuporedivo jeftinije od tradicionalnih rasvetnih metoda. Laka montaza i izvanredan svetlosni efekat u kombinaciji sa originalnim, modernim dizajnom, primenljiv je kod mnoštva aplikacija

Preduzeće GAUS Group Pozarevac se bavi uvozom i distribucijom LED rasvete Music line.



**MUSIC LINE** proizvod poljske kompanije Skoff nosilac je prestizne nagrade - **ZLATNE MEDALJE** na **MEDJUNARODNOM SAJMU POZNAŃ**

# Rasveta za:

hodnike - pri dnu



stepeništa - ispod stepenica

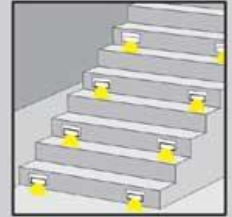

stepeništa - sa strane

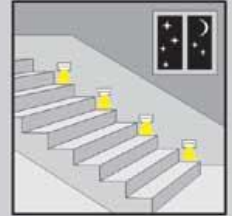

hodnike - pri vrhu



kuhinje



nameštaj



nameštaj - šankovi



kupatila





LED UGRADNA RASVETA

## Tango

**Spoljna površina:**

- K - STAINLESS STEEL
- G - ALUMINIUM

- vrednost napona 10V=

**Nominalna snaga:**

- BELA (W) - 0,8W
- CRVENA (R) - 1,0W
- ZELENA (G) - 0,6W
- PLAVA (B) - 0,8W

Montaza u ø60mm kutiju



IP20 F B CE



LED UGRADNA RASVETA

## Rueda

**Spoljna površina:**

- K - STAINLESS STEEL
- G - ALUMINIUM

- vrednost napona 10V=

**Nominalna snaga:**

- BELA (W) - 0,8W
- CRVENA (R) - 1,0W
- ZELENA (G) - 0,6W
- PLAVA (B) - 0,8W

Montaza u ø60mm kutiju



IP20 F B CE

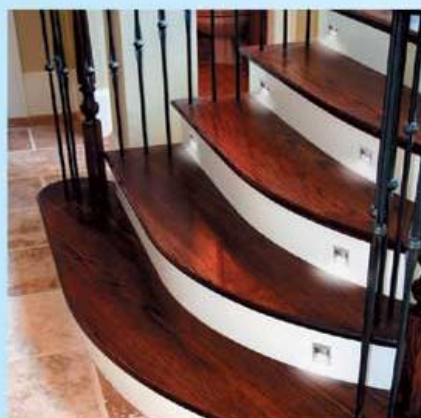

LED UGRADNA RASVETA

## Tango

mini

**Spoljna površina:**

- K - STAINLESS STEEL
- G - ALUMINIUM

- vrednost napona 10V=

**Nominalna snaga:**

- BELA (W) - 0,4W
- CRVENA (R) - 0,5W
- ZELENA (G) - 0,3W
- PLAVA (B) - 0,4W

Montaza u ø50mm otvor



IP20 F B CE



LED UGRADNA RASVETA

## Rueda

mini

**Spoljna površina:**

- K - STAINLESS STEEL
- G - ALUMINIUM

- vrednost napona 10V=

**Nominalna snaga:**

- BELA (W) - 0,4W
- CRVENA (R) - 0,5W
- ZELENA (G) - 0,3W
- PLAVA (B) - 0,4W

Montaza u ø50mm otvor



IP20 F B CE

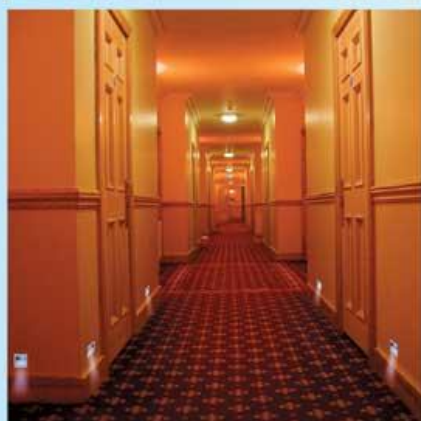

LED RASVETNA TELA

# Tango

STICK

Spoljna površina:  
G - ALUMINIJUM

• vrednost napona 10V=

Nominalna snaga:

- BELA (W) - 0,8W
- CRVENA (R) - 1,0W
- ZELENA (G) - 0,6W
- PLAVA (B) - 0,8W



LED RASVETNA TELA

# Rueda

STICK

Spoljna površina:  
G - ALUMINIJUM

• vrednost napona 10V=

Nominalna snaga:

- BELA (W) - 0,8W
- CRVENA (R) - 1,0W
- ZELENA (G) - 0,6W
- PLAVA (B) - 0,8W



LED RASVETNA TELA

# Tango

mini STICK

Spoljna površina:  
K - STAINLESS STEEL  
G - ALUMINIJUM

• vrednost napona 10V=

Nominalna snaga:

- BELA (W) - 0,4W
- CRVENA (R) - 0,5W
- ZELENA (G) - 0,3W
- PLAVA (B) - 0,4W



LED RASVETNA TELA

# Rueda

mini STICK

Spoljna površina:  
K - STAINLESS STEEL  
G - ALUMINIJUM

• vrednost napona 10V=

Nominalna snaga:

- BELA (W) - 0,4W
- CRVENA (R) - 0,5W
- ZELENA (G) - 0,3W
- PLAVA (B) - 0,4W





LED RASVETNA TELA

*duo*

# Tango

**Spoljna površina:**

- K - STAINLESS STEEL
- G - ALUMINIUM

• vrednost napona 10V-

**Nominalna snaga:**

- BELA (W) - 1,6W
- CRVENA (R) - 2,0W
- ZELENA (G) - 1,2W
- PLAVA (B) - 1,6W

Montaza  
u ø60mm kutiju



73  
113  
IP20 F B CE



LED RASVETNA TELA

*duo*

# Rueda

**Spoljna površina:**

- K - STAINLESS STEEL
- G - ALUMINIUM

• vrednost napona 10V-

**Nominalna snaga:**

- BELA (W) - 1,6W
- CRVENA (R) - 2,0W
- ZELENA (G) - 1,2W
- PLAVA (B) - 1,6W

Montaza  
u ø60mm kutiju



73  
113  
IP20 F B CE

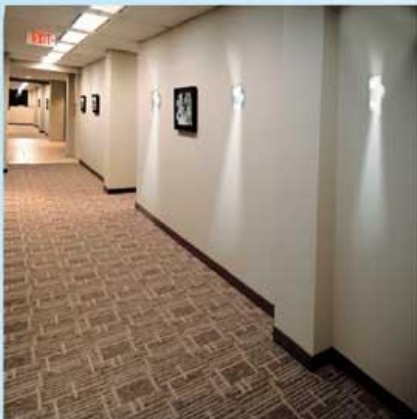

LED RASVETNA TELA

KINKIET *duo*

# Tango

**Spoljna površina:**

- G - ALUMINIUM

• vrednost napona 10V-

**Nominalna snaga:**

- BELA (W) - 1,6W
- CRVENA (R) - 2,0W
- ZELENA (G) - 1,2W
- PLAVA (B) - 1,6W

Montaza  
u P70N kutiju  
na zidu



10,5 25  
73  
113  
IP20 F B CE

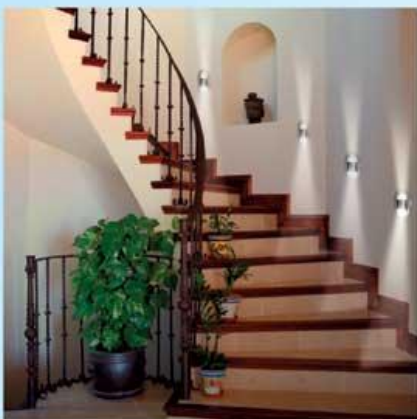

LED RASVETNA TELA

KINKIET *duo*

# Rueda

**Spoljna površina:**

- G - ALUMINIUM

• vrednost napona 10V-

**Nominalna snaga:**

- BELA (W) - 1,6W
- CRVENA (R) - 2,0W
- ZELENA (G) - 1,2W
- PLAVA (B) - 1,6W

Montaza  
u P70N kutiju  
na zidu

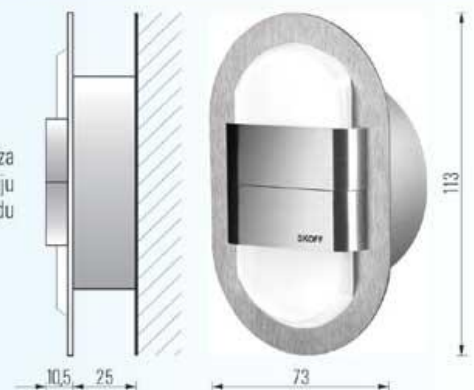

10,5 25  
73  
113  
IP20 F B CE



LED RASVETNA TELA

# Rumba

Spoljašna površina:  
G - ALUMINIJUM

• vrednost napona 10V=

Nominalna snaga:

- BELA (W) - 0,8W
- CRVENA (R) - 1,0W
- ZELENA (G) - 0,6W
- PLAVA (B) - 0,8W



• vrednost napona 10V=



## IZVOR NAPAJANJA ZA LED RASVETNA TELA

### tip ZOL 6 / 10V- 6W

- napon napajanja 100 ÷ 230 V / 50 ÷ 60 Hz
- izlazni napon 10 V - 6 W
- klasa zaštite KL. 2
- izvedba : hermeticka
- obezbedjena zaštita od kratkog spoja i preopterećenja



## ŠEMA ELEKTRIČNE VEZE

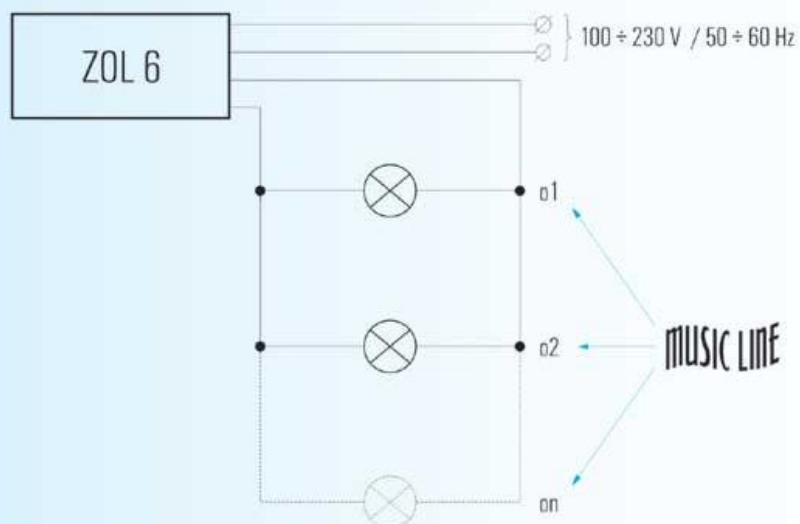

maksimalna snaga = max 6 W ( ZOL 6 )



TC Novi dom, Moše Pijade bb  
12 000 Požarevac  
tel./fax 012/530-700

[office@gausgroup.com](mailto:office@gausgroup.com)  
[www.gausgroup.com](http://www.gausgroup.com) , [rasveta.gausgroup.com](http://rasveta.gausgroup.com)